



1-Port Series Vector Network Analyzer Specifications



| | |
|-----------------|--|
| R60 | 1 MHz to 6 GHz |
| R140B | 85 MHz to 14 GHz |
| Software | CMT VNA software, Windows and Linux, demo mode supported |

Revision 25.00 25.11.2025

General Overview

Main Parameters

R60

| | |
|-------------------------------------|--|
| Configuration | Reflectometer, 50 Ohm |
| Measured parameters | S11 as Log magnitude, DTF, Smith, and more |
| Frequency range | 1 MHz to 6 GHz |
| Sweep types | linear frequency, log frequency, segment |
| Effective directivity | |
| 1 MHz to 6 GHz | 46 dB |
| Measurement time per point | 100 μ s |
| Measurement points per sweep | up to 100,001 |
| Connection | USB |
| Software | CMT VNA, Windows or Linux |

R140B

| | |
|-------------------------------------|--|
| Configuration | Reflectometer, 50 Ohm |
| Measured parameters | S11 as Log magnitude, DTF, Smith, and more |
| Frequency range | 85 MHz to 14 GHz |
| Sweep types | linear frequency, log frequency, segment |
| Effective directivity | |
| 85 MHz to 4.8 GHz | 45 dB |
| 4.8 GHz to 14 GHz | 42 dB |
| Measurement time per point | 170 μ s |
| Measurement points per sweep | up to 100,001 |
| Output power setting | high or low |
| Connection | USB |
| Software | CMT VNA, Windows or Linux |
| Demo mode | Free software option |

CMT VNA software runs natively on Windows and Linux. It can also be used on x86 or ARM processors on PCs, tablets, or single-board computers including Raspberry Pi.

Functionality and Features Overview

- Intuitive software control through a two-level menu, quick access toolbar, channel status bar, and hot keys.
- Multi-channel mode. No limitations on the number of channels, diagrams, traces, or markers.
- Sweep by frequency: linear, logarithmic or segment mode, by power: linear, by time: CW mode.
- The software implements data, memory, and static traces. Available trace functions include trace hold, smoothing, statistical data calculation, and standard mathematical operations.
- Calibration wizard with workflow progress and step guidance. The wizard works in conjunction with the calibration kit and connector libraries. The libraries include numerous predefined items. Multiple calibration methods are supported.
- Fixture simulator includes the port extension feature, embedding and de-embedding functions, and impedance conversion.
- For post-processing of measurement data, markers and limit tests are available. Marker search and marker math functions are supported.
- In the basic version, the software supports time domain measurements with gating.
- All state, calibration and measurement data can be saved to a state file. The software allows the user to save S-parameters to a touchstone file, and an individual trace's data as a CSV file.
- A print function is provided. This function also supports saving data according to a predefined template, with the option to include supplementary information related to the operator, DUT, and experimental conditions.
- Automation programming in Python, LabVIEW, MATLAB, .NET, etc.

1-Port Series Vector Network Analyzer Specifications

CMT VNA Software

The Software Application is Part of the VNA

The analyzers include an RF measurement module, and a software application. The software application takes raw measurement data from the data acquisition (measurement) module and transforms into S-parameters in multiple presentation formats utilizing proprietary algorithms. The calibration and other accuracy enhancing algorithms were developed by our metrology experts.

The instruments use CMT VNA software, which can be installed on x86- or ARM-based processors and controlled via a USB interface. The software features an intuitive user interface with all available options organized in sub-menus, enabling quick and efficient navigation between different functions.

Two-level menu

Quick access toolbar

Hot keys

Calibration wizard

Kits and connectors libraries

Trace manager

Trace and marker math

Data analysis including markers and limit tests

Save/recall files and states, print

Automation

Free demo mode

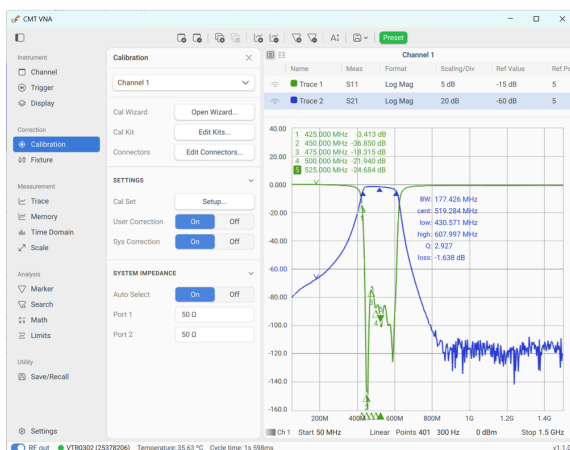

The CMT VNA software can be downloaded free from our website, used on an unlimited number of PCs using either Linux or Windows operating systems, and enables easy analyzer integration with other software applications and automation. The software application features a fully functioning Demo Mode, which can be used for testing automation scripts and exploring the analyzers' features and capabilities without an actual measurement module connected to your PC.

Our software offers flexible options for controlling the analyzers. Users can configure parameters through a **two-level menu**, the **quick access toolbar**, the **channel status bar**, or by pressing **hotkeys**. The quick access toolbar can be customized to individual preferences, ensuring maximum efficiency and a personalized workflow.

Service

Accredited Calibration Labs



Periodic verification is used to check the instrument to ensure that it is operating within its specifications. Two years is recommended, but the interval should be determined by your organization's quality policy.

Our Indianapolis and Cyprus calibration laboratories are accredited in accordance with the recognized international standard ISO/IEC 17025 (2017) and meet the requirements of ANSI/NCSL Z540-1994-1.

Warranty, Service, & Repairs

All our products come with a standard three-year warranty from date of shipment. During that time we will repair or replace any product malfunctioning due to defective parts or labor.

While we pride ourselves on quality of our instruments, should your VNA malfunction for any reason, we will gladly offer a loaner unit while we service yours. With our USB VNAs where all data is stored on your PC, a simple swap of the measurement module assures uninterrupted workflow and little or no downtime.

The Crown Customer Service Package

The package includes support that goes beyond the analyzer. Our expert engineers give guidance to customers using CMT analyzers regarding their measurement setup, automation, and much more. This package provides an unparalleled level of service before, during, and after the purchase of the analyzer. And the best part? It's included with every purchase from every company. We are always here to provide reliable and timely customer support.

Automation Support

We understand that your time is valuable, which is why our team strives to provide rapid support for engineers using automation in their testing. Because we want to keep you working, our Crown Customer Service package includes help with setting up your testing automation for your analyzer. Our engineers have lots of experience with many coding languages, like C++, Python, MATLAB*, Visual Basic (Excel)*, and LabVIEW*.



Supporting Unique Applications

Technological advancements have engineers using analyzers for more things than ever before.

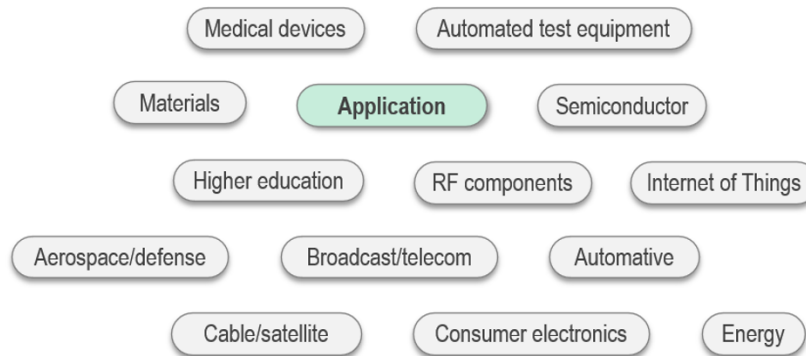

Customers are using CMT analyzers in industries such as agriculture, automotive R&D and manufacturing tests, medical applications, the expansive network of IoT and IIoT, energy, and more. Determining the ideal analyzer often requires extensive research, so the Crown Customer Support Package includes a consultation with our technical staff to discuss your specific application and recommend the best options. This support package comes at no charge with the purchase of a Copper Mountain Technologies VNA.

Having Issues with Your Analyzer?

We have built and supply high-quality test equipment we are proud of and stand behind. However, we know that issues happen, and when they do, we are here to help. Be it software support, repairs, or just a routine annual verification, the Crown Customer Service Package includes beyond-average rapid support for all of these occurrences. Our service and support teams do all they can to get the analyzer back to making accurate measurements as soon as possible.

For more detailed information, please visit our website:

<https://coppermountaintech.com/crown-customer-service-package/>

Standard Measurement Capabilities

Measurement Parameters

CMT 1-Port VNAs can measure return loss as low as 35 dB, across the full frequency range of each instrument. Consult the specifications of each instrument for more detail.

Calibration data can also be displayed on the screen to verify the quality of the performed calibration.

Data Display Formats

Logarithmic magnitude, linear magnitude, phase, expanded phase, group delay, SWR, real and imaginary parts, and polar diagram.

Number of Channels, Diagrams, and Traces

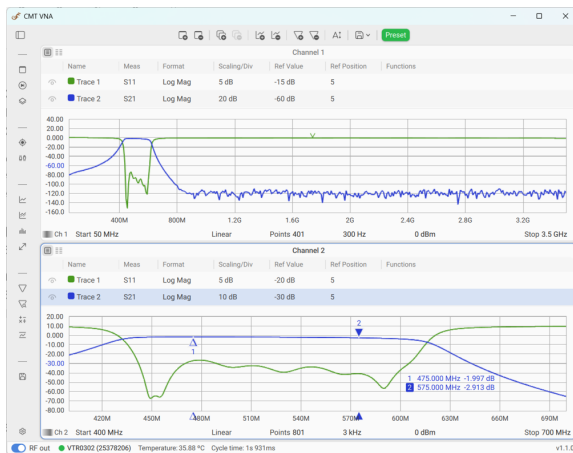

Two Channels with Individual Settings

CMT VNA software allows users to create as many channels as needed, enabling precise customization of each measurement through individual channel settings and calibration.

A channel is considered to be a separate logical analyzer with its own unique settings.

To facilitate working with the numerous available parameters, the table below presents the instrument settings grouped into two categories: channel and trace.

| | |
|------------------|--|
| Channel settings | Sweep range, number of points, power level, CW frequency, segment sweep table, IF bandwidth, averaging, trigger mode, calibration, fixture simulator. |
| Trace settings | Measured parameter along with conversions, display format, scale settings, electrical delay, phase offset, memory trace, math operation, smoothing, time domain, markers with search and math functions, limit test, ripple limit test, peak limit test. |

1-Port Series Vector Network Analyzer Specifications

The software features a zoom function that allows you to easily focus on and analyze a specific part of the diagram in more detail.

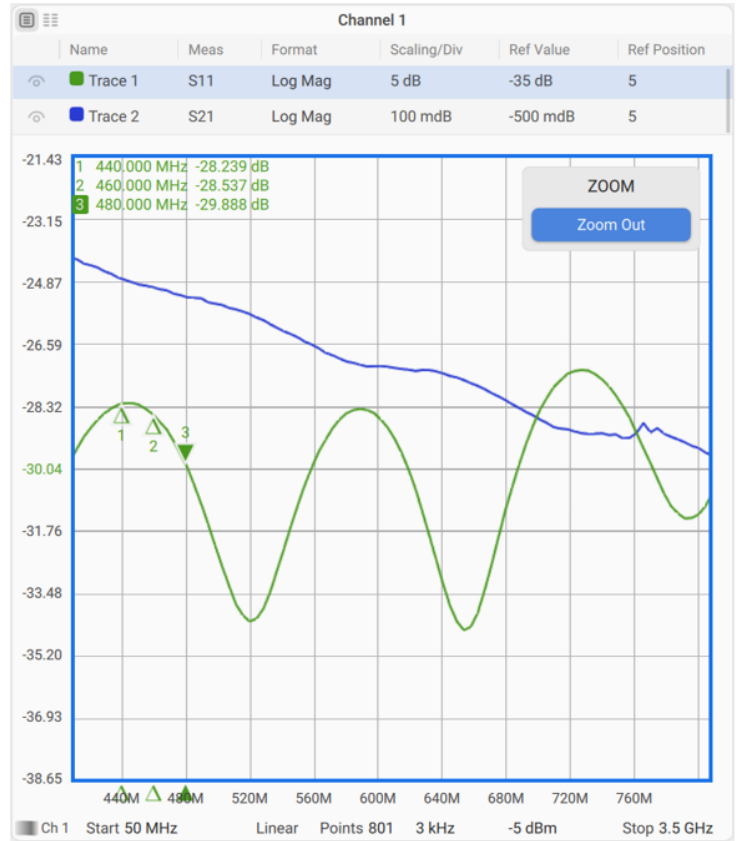

Software Capabilities

Sweep Features

| | |
|------------|--|
| Sweep type | Sweep range, number of points, power level, CW frequency, segment sweep table, IF bandwidth, averaging, trigger mode, calibration, fixture simulator. |
| Trigger | Measured parameter along with conversions, display format, scale settings, electrical delay, phase offset, memory trace, math operation, smoothing, time domain, markers with search and math functions, limit test, ripple limit test, peak limit test. |

Segment Sweep

In applications where a continuous sweep may be undesirable, this function allows the user to sweep frequency segments rather than the entire frequency span. This can lead to faster measurement results.

A frequency sweep can be made within several independent user-defined segments.

Frequency range, number of sweep points, IF bandwidth, source power, and delay can be set for each segment.

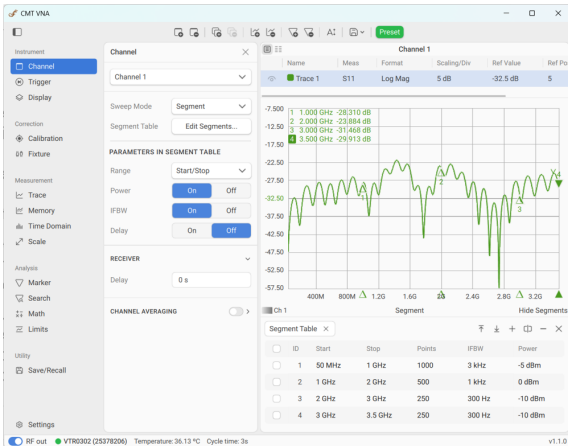

Segment Sweep Feature

Power Sweep

The power sweep feature enables users to perform compression point recognition, one of the most fundamental and complex amplifier measurements, in a simple manner.

In this case, you can use either S21 transmission or the test receiver power measurements.

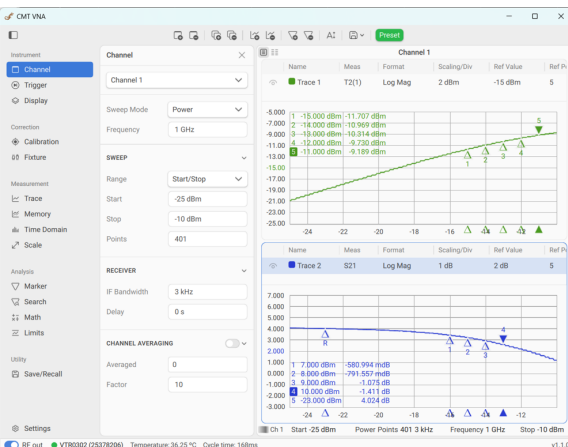

Power Sweep

Trace Functions

CMT VNA software incorporates many trace functions, such as:

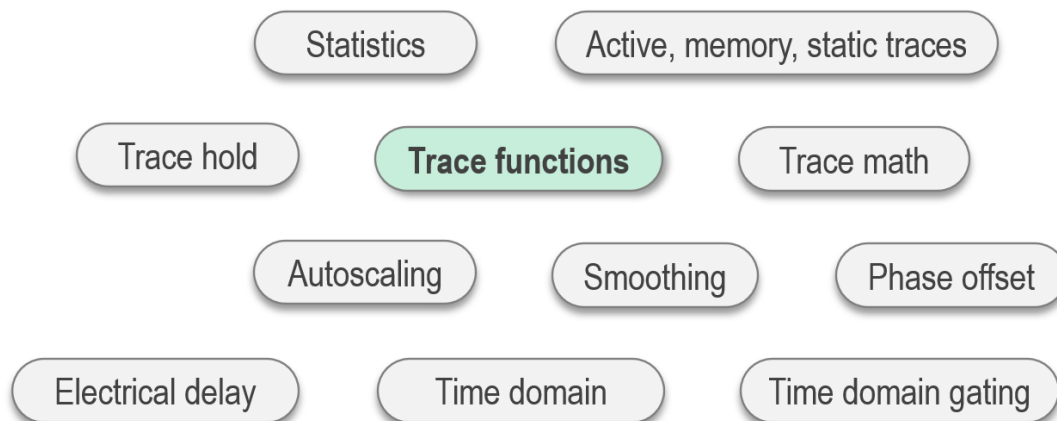

| | |
|------------------|--|
| Traces | Data trace, memory trace, or simultaneous indication of data and memory traces. |
| Static trace | You can recall data from a file and perform any calculation using the full range of functions available in the software. |
| Trace math | Data trace modification by math operations: addition, subtraction, multiplication or division (normalization) of measured complex values and memory data. |
| Smoothing | Smoothing averages the adjacent points of the trace by the moving window. Smoothing helps to reduce trace noises. Smoothing is set for each trace independently. |
| Statistics | The trace statistics feature allows to determine and view trace parameters, such as mean, standard deviation, and peak-to-peak. The range of trace statistics can be defined by two markers or band. |
| Trace hold | The trace hold function is used to hold the maximum or minimum values of the trace. |
| Autoscaling | Automatic selection of scale division and reference level value to have the trace most effectively displayed. |
| Electrical delay | The electrical delay function compensates for the delay of the trace measurement. This function is useful during measurements of phase deviations from linear. |
| Phase offset | The function applies a chosen constant phase offset to S-parameter measurements at all frequencies. |

Time Domain Measurements

This function performs conversion of the DUT response from frequency domain to time domain.

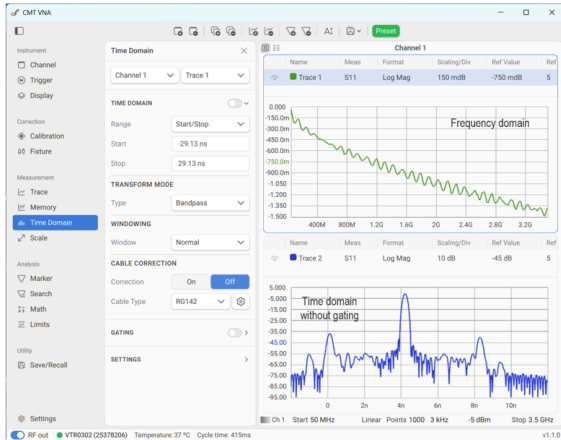

Modeled time domain stimulus types are bandpass, lowpass impulse, and lowpass step.

The time domain span is determined by the frequency span and the number of measurement points.

Windowing functions of various shapes are used for tradeoff between resolution and levels of spurious sidelobes.

Cable Measurement with Open at the End

Time Domain Gating

This function mathematically removes unwanted responses in the time domain, allowing the user to obtain a frequency response without the effects of fixture elements.

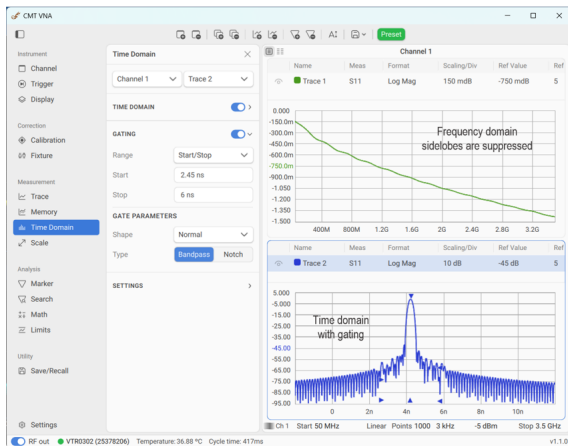

Reflections occurring within a chosen time span may be bandpass gated such that all other reflections are suppressed or notch gated such that reflections in the chosen time span are suppressed.

After time domain gating, the result with chosen reflections removed may be viewed in the frequency domain. Gating filter types are bandpass or notch. For a better tradeoff between gate resolution and level of spurious sidelobes the following filter shapes are available: maximum, wide, normal and minimum.

Cable Measurement with Open at the End

Data Analysis

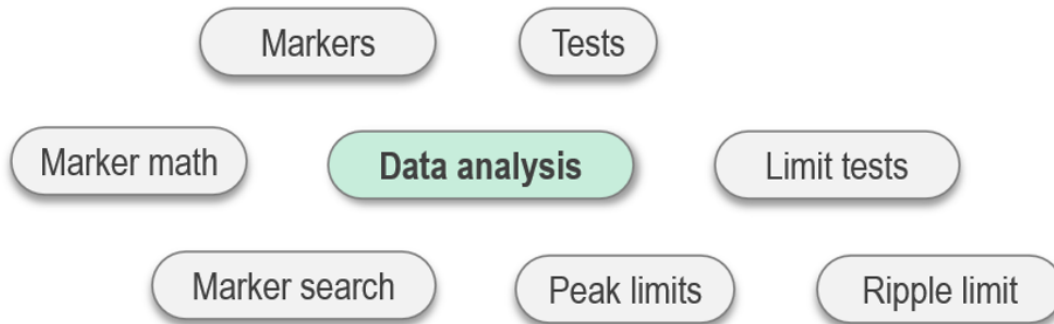

| | |
|---------------|--|
| Markers | Marker tools are used to read and look up the numerical values of the stimulus and the measured value on selected points on the graph. The software has no limitations on the number of markers. |
| Marker search | The marker position search function allows the user to find the following values on a trace: maximum value, minimum value, peak value, target level. |
| Marker math | Marker math functions use markers to calculate various trace characteristics: trace statistics, bandwidth/notch search, flatness evaluation, RF filter statistics. |
| Limit tests | The limit test is a function of automatic pass/fail judgment for the trace of the measurement result. |
| Ripple limit | The ripple limit test is an automatic pass/fail check of the measured trace data. The trace is checked against the maximum ripple value. The ripple value is the difference between the maximum and minimum response of the trace in the trace frequency band. |
| Peak limits | The peak limits test function checks whether the trace point with the minimum or maximum value of the measured value falls within the specified limits of the frequency range and/or value range. |

Limit Testing

Limit testing is a function that provides automatic pass/fail evaluation based on measurement results. The trace is compared against a user-defined limit line, which may consist of one or multiple segments. This function allows users to quickly verify compliance with specified requirements by comparing measurement traces against predefined thresholds. This ensures efficient quality control, accelerates testing, and reduces the risk of overlooking deviations from specifications.

Each segment verifies whether the measurement value exceeds the upper limit, falls below the lower limit, or both. A limit line segment is defined by specifying the start coordinates (X0, Y0) and stop coordinates (X1, Y1), along with the limit type. The MAX and MIN limit types check whether the trace re-mains below or above the defined limit line, respectively.

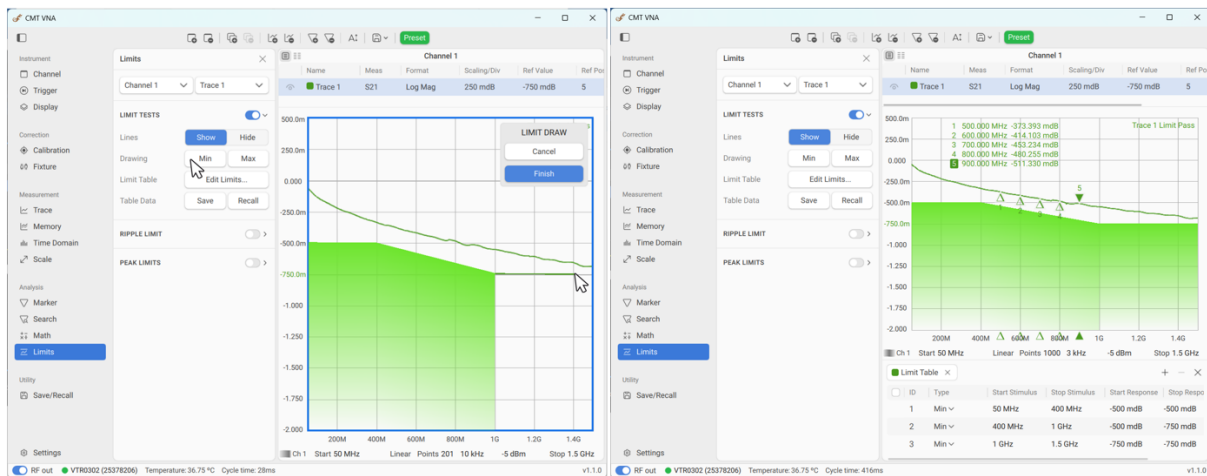

Limit lines can be created either interactively using the mouse or by entering values directly into the limit table. The limit line can be drawn in with more than two points. Alternatively, choose the limit table button and enter the limit line values.

Calibration

Calibration can be done using the new **Basic calibration wizard**, which allows for easy and intuitive calibration using enabled calibration kits.

The screenshot displays three overlapping windows from the software interface:

- Connectors Library - CMT VNA:** A table listing various connector types, impedances, and maximum frequencies.
- Calibration Kits - CMT VNA:** A table listing various calibration kit models, descriptions, connector types, and manufacturers.
- Quick Calibration - CMT VNA:** A configuration window for selecting a calibration kit, type, and plane settings.

| Type | Impedance | Max Frequency |
|-------------|-----------|---------------|
| 0.8 mm | 50 Ω | 145 GHz |
| 14 mm | 50 Ω | 8.5 GHz |
| 1.35 mm | 50 Ω | 90 GHz |
| 1.85 mm | 50 Ω | 67 GHz |
| 1 mm | 50 Ω | 110 GHz |
| 2.4 mm | 50 Ω | 50 GHz |
| 2.92 mm | 50 Ω | 40 GHz |
| 3.5 mm | 50 Ω | 33 GHz |
| 4.3-10 | 50 Ω | 12 GHz |
| 7-16 | 50 Ω | 7.5 GHz |
| 7 mm | 50 Ω | 18 GHz |
| Type-N 50 Ω | 50 Ω | 18 GHz |
| Type-N 75 Ω | 75 Ω | 18 GHz |

| Model | Description | Connector | Manufacturer |
|--------------|------------------------------|-------------|-----------------|
| C24F | 50 GHz SOLT | 2.4 mm | CMT |
| CM292F | 40 GHz SOLT | 2.92 mm | CMT |
| F7511 | 3 GHz SOLT | Type-N 75 Ω | CMT |
| Flann WR137 | C-band 5.38-8.18G SSLT/TL... | WR137 | Flann Microwave |
| Flann WR159 | F-band 4.64-7.05G SSLT/TL... | WR159 | Flann Microwave |
| Flann WR187 | G-band 3.94-5.99G SSLT/TL... | WR187 | Flann Microwave |
| Flann WR229 | E-band 3.3-4.9G SSLT/TRL... | WR229 | Flann Microwave |
| Flann WR284 | S-band 2.6-3.95G SSLT/TRL... | WR284 | Flann Microwave |
| N1801 | 18 GHz SOLT | Type-N 50 Ω | CMT |
| N1802 | 18 GHz SOLT | Type-N 50 Ω | CMT |
| N611 | 6 GHz SOL | Type-N 50 Ω | CMT |
| N612 | 6 GHz SOL | Type-N 50 Ω | CMT |
| N911 | 9 GHz SOL | Type-N 50 Ω | CMT |
| N912 | 9 GHz SOL | Type-N 50 Ω | CMT |
| N3.5 | 3.5 GHz SOLT | Type-N 50 Ω | CMT |
| S2611 | 26.5 GHz SOLT | 3.5 mm | CMT |
| S911T | 9 GHz SOLT | 3.5 mm | CMT |
| ZV-Z135 | 15GHz SOLT Cal Kit | 3.5 mm | Rohde Schwarz |
| 90C63 | Type N MALE 18 GHz | Type-N 50 Ω | CMT EU |
| RS-F-Primary | Type N FEMALE | Type-N 50 Ω | Rohde Schwarz |

Quick Calibration - CMT VNA Configuration:

- Ports: 1 Port, **2 Ports**, 3 Ports, 4 Ports
- Calibration Kit: 90C63
- Calibration Type: Type-N 50 Ω
- Calibration Type: One Path N-Port
- Plane Settings:
 - VNA Port: Port 1, Port 2
 - DUT Gender: Male, Female
- Settings: Source Port: Port 1
- Start button

1-Port Series Vector Network Analyzer Specifications

| | |
|---------------------------------|--|
| Calibration wizard | The basic calibration wizard is a simple and intuitive tool for performing analyzer calibration. It guides the user through the calibration process, indicating which standards need to be connected and how many steps are required. |
| Calibration methods | The following calibration methods of various sophistication and accuracy are available: reflection (open, short, both open and short) and transmission response, full 1-port calibration, 1-path 2-port calibration. |
| Error correction interpolation | Interpolation or extrapolation of the calibration coefficients will be applied when the user changes any settings such as the start/stop frequencies or the number of sweep points, compared to the settings at the moment of calibration. Extrapolation is not recommended for accurate measurements. |
| Kit library | This library stores definitions of calibration kits, both predefined and user-created. A search function can be used to locate the required definition. Definitions can be saved to a file and later used at different workstations. Definitions marked as "Favorite" will appear first in the list of available kits during calibration. |
| Calibration standard definition | Different methods of calibration standard definition are available: standard definition by polynomial model and standard definition by Touchstone data file (S-parameters). |
| Connector library | This library is designed to store connectors, categorized into coaxial and waveguide types. By default, the library contains a comprehensive set of standardized connectors. |

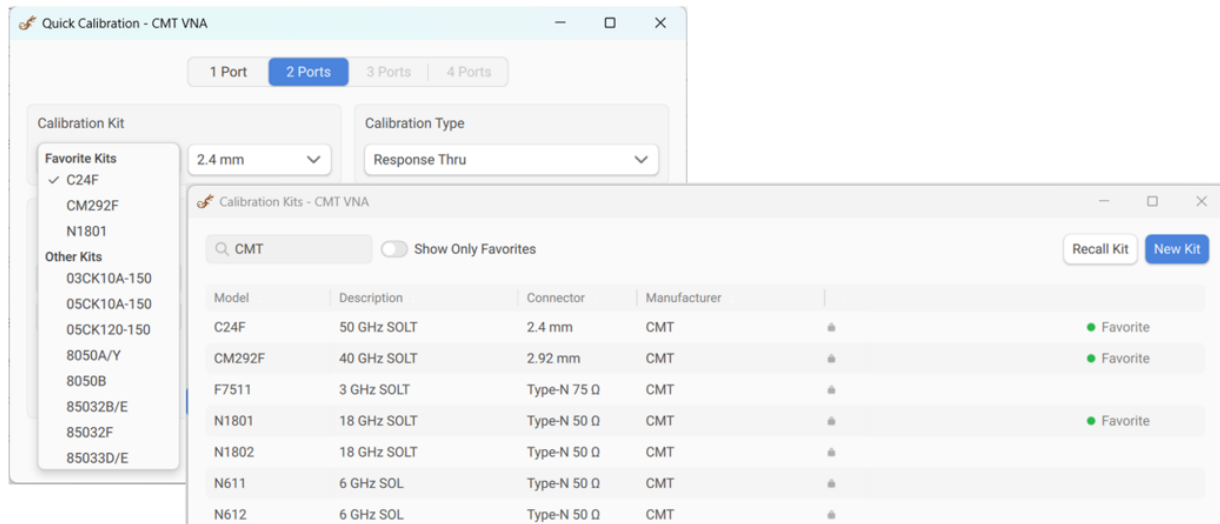

Kit Library with "Favorites" Marked

1-Port Series Vector Network Analyzer Specifications

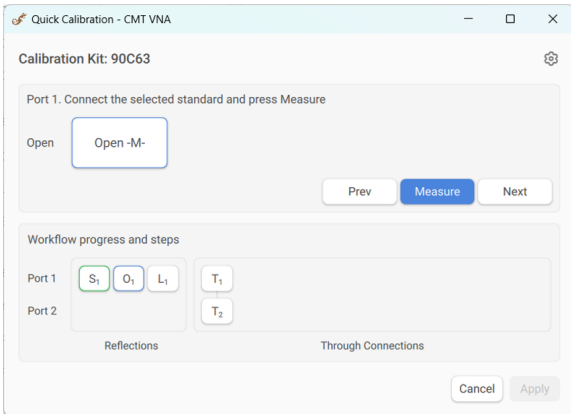

Basic Calibration Wizard

Calibration of a test setup (which includes the analyzers, cables, and adapters) significantly increases the accuracy of measurements.

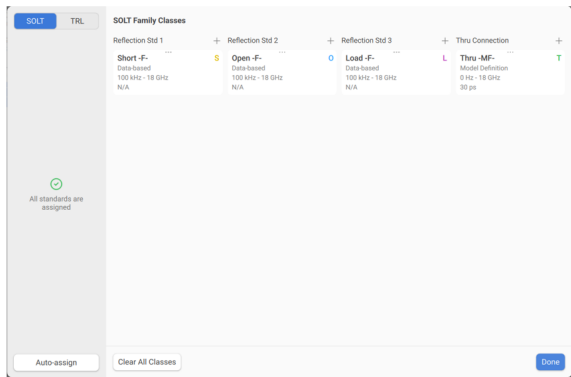

Creating the Kit Definition and Class Assignment

The software allows for class assignment to be done automatically to simplify user kit creation. The assignment is carried out after adding a new standard and selecting its type.

The standards are arranged in a sequence that makes it easy to identify which type of calibration they support. For example, in the figure, the letters SOLT are clearly visible, indicating that the Short, Open, Load, and Thru standards will need to be connected during calibration.

Fixture

This section includes a set of functions that either modify the position of the calibration plane or recalculate the scattering matrix parameters.

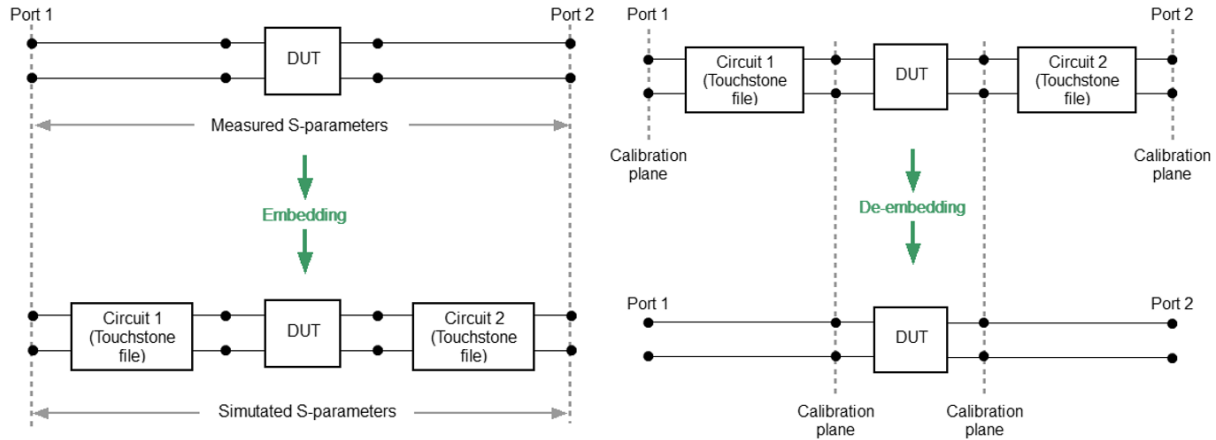

| | |
|----------------------------------|--|
| <p>Embedding</p> | <p>Embedding is a function of the S-parameter transformation via integration of some virtual circuit into the real network. The function allows the user to mathematically simulate the DUT parameters after adding the fixture circuits.</p> |
| <p>De-embedding</p> | <p>De-embedding is a function of transforming the S-parameter by eliminating some circuit effect from the measurement results. The function allows the user to mathematically exclude the effect of the fixture circuit existing between the calibration plane and the DUT in the real network from the measurement results.</p> |
| <p>Port impedance conversion</p> | <p>Port reference impedance conversion is a function that mathematically converts the matrix of S-parameters measured at the reference impedance of port Z_0 to the matrix of S-parameters measured at an arbitrary impedance of port Z_1.</p> |

Data Output

| | |
|------------------|---|
| Analyzer state | All state, calibration and measurement data can be saved to a state file on the hard disk and later recalled into the software. The software supports the Quick Save to List function for storing analyzer settings and quickly switching between saved configurations. |
| Touchstone files | This selection allows users to save S-parameters to a Touchstone file, which contains frequency values along with the corresponding S-parameters. Touchstone files are an industry-standard format supported by most circuit simulation programs. The .s2p files are used to store all S-parameters of a device, while .s1p files are used to store either the S11 or S22 parameter of a one-port device. Additionally, the software can function as a Touchstone file viewer, enabling users to graphically display and analyze previously saved Touchstone files. |
| CSV files | This selection allows users to save an individual trace's data as a CSV file (comma separated values). |

Screenshot capture



COPPER MOUNTAIN
TECHNOLOGIES

MEASUREMENT REPORT

Device under test: Cable measurements
 Vector network analyzer: VTR0302
 Location: Copper Mountain Technologies EU LTD

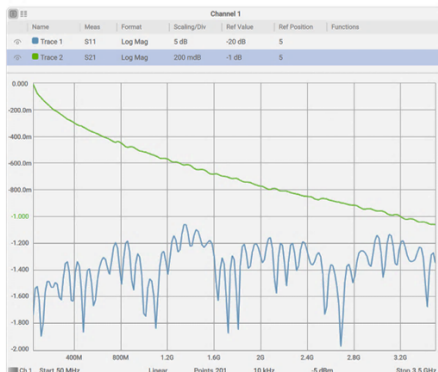

Template of a Report Generated by
CMT VNA Software

Screenshots can be printed using three different applications: MS Word, Image viewer for Windows, or the Print wizard.

Each screenshot can be printed in color, grayscale, or inverted for visibility or to save ink.

The current date and time can be added to each capture before it is transferred to the printing application, resulting in quick and easy test reporting.

A Word template file can be customized to change the appearance of the MS Word file output.

This function enables users to save measurement data in accordance with a predefined template, with the capability to incorporate supplementary information regarding the operator, the device under test (DUT), and the experimental conditions.

Automation

We maintain code examples and guides in the following languages:



SCPI via TCP Socket

Alternatively a TCP socket is provided for automation from either localhost - the same machine running the analyzer software application - or from a second PC connected by an IP network. The SCPI commands are largely compatible with legacy instruments, maximizing code reuse for existing test automation platforms

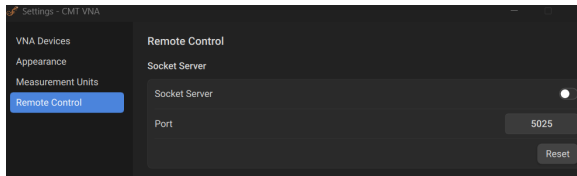

Remote Control in the Settings

SCPI via TCP Socket can be used with either Windows or Linux operating systems.

LabVIEW Compatible

The instrument and its software are fully compatible with LabVIEW applications, for ultimate flexibility in user-generated programming and automation. LabVIEW can be used with Windows OS only.

Hardware Specifications

R60

Measurement Range

| | |
|---|-------------------------|
| Impedance | 50 Ohm |
| Test port connector | type N, male |
| Number of test ports | 1 |
| Frequency range | 1 MHz to 6 GHz |
| Full frequency accuracy | $\pm 2.5 \cdot 10^{-6}$ |
| Frequency resolution | 20 Hz |
| Number of measurement points | 2 to 100,001 |
| Measurement bandwidths (with 1/3 steps) | 10 Hz to 100 kHz |
| Cable loss measurement range | 35 dB |
| Dynamic range ² | 109 dB typ |

[2] Measurement of |S21| and |S12| using two reflectometers, both being connected to the same USB hub, applies over the temperature range of $(23 \pm 5)^\circ\text{C}$ after 30 minutes of warming-up, with less than 1°C deviation from the calibration temperature at high output power and IF bandwidth 100 Hz.

Measurement Accuracy^[3]

| Accuracy of reflection measurements ⁴ | Magnitude/Phase |
|--|-----------------|
| -15 dB to 0 dB | ±0.4 dB / ±3° |
| -25 dB to -15 dB | ±1.0 dB / ±6° |
| -35 dB to -25 dB | ±3.0 dB / ±20° |
| Accuracy of transmission magnitude measurements ⁵ | |
| -50 dB to 0 dB | ±0.4 dB / ±3° |
| Trace noise magnitude ⁶ | 0.005 dB rms |
| Temperature dependence | 0.015 dB/°C |

[3] Reflection and transmission measurement accuracy applies over the temperature range of (73 ± 9) °F or (23 ± 5) °C after 30 minutes of warming up, with less than 1°C deviation from calibration temperature, at 0 dBm output power and IF BW 100 Hz. Frequency points have to be identical for measurement and calibration (no interpolation allowed).

[4] Reflection specifications are based on an isolating DUT.

[5] Transmission specifications are based on a matched DUT. Measurement of |S21| and |S12| using two devices, both being connected to the same USB hub.

[6] IF bandwidth 1 kHz.

Effective System Data

| | |
|-----------------------|----------|
| 1 MHz to 6 GHz | |
| Directivity | 46 dB |
| Source match | 40 dB |
| Reflection tracking | ±0.05 dB |

Factory-Calibrated System Data

| | |
|-----------------------|-------|
| 1 MHz to 4 GHz | |
| Directivity | 36 dB |
| 4 GHz to 6 GHz | |
| Directivity | 32 dB |

Uncorrected System Performance

| | |
|-----------------------|--------------------|
| 1 MHz to 6 GHz | |
| Directivity | 15 dB (18 dB typ.) |
| Source match | 15 dB (18 dB typ.) |

Test Port

| | |
|------------------------------|--|
| Power range | -35 dBm to -3 dBm (-40 dB to 0 dB, typ.) |
| Power resolution | 0.25 dB typ. |
| Power accuracy | ±1.5 dB typ. |
| Interference immunity | +17 dBm |
| Damage level | +23 dBm |
| Damage DC voltage | 50 V |

Measurement Speed

| | |
|-----------------------|-------------|
| Time per point | 100 μs typ. |
|-----------------------|-------------|

Frequency Reference Input

| | |
|------------------------------|----------------|
| Port | Ref 10 MHz |
| External reference frequency | 10 MHz |
| Input level | 0 dBm to 4 dBm |
| Input impedance | 50 Ohm |
| Connector type | SMA, female |

Frequency Reference Output

| | |
|---|-----------------|
| Port | Ref 10 MHz |
| Internal reference frequency | 10 MHz |
| Output reference signal level at 50 Ohm impedance | -1 dBm to 5 dBm |
| Connector type | SMA, female |

Trigger Input

| | |
|-------------------------|----------------------------|
| Port | TRIG IN/OUT |
| External trigger source | 3.3 V CMOS, TTL compatible |
| Pulse width | $\geq 1 \mu\text{s}$ |
| Polarity | positive or negative |
| Input impedance | $\geq 10 \text{ k}\Omega$ |
| Connector type | SMA, female |

Trigger Output

| | |
|--------------------|----------------------------|
| Port | TRIG IN/OUT |
| Max output current | 20 mA |
| Trigger output | 3.3 V CMOS, TTL compatible |
| Polarity | positive or negative |
| Connector type | SMA, female |

1-Port Series Vector Network Analyzer Specifications

System & Power

| | |
|-------------------------------------|-------------------------------|
| CMT VNA software: | |
| Operating system (min requirements) | Windows 10, Ubuntu 24.04 |
| CPU | 4 core 2.0 GHz (x64 or arm64) |
| RAM | 8 GB |
| Interface | USB 2.0 |
| Connector type | Mini USB B |
| Power consumption | 3.5 W |

Calibration

| | |
|--|---------|
| Recommended factory adjustment interval | 3 Years |
|--|---------|

Dimensions

| | |
|---------------|-------------------|
| Weight | 0.35 kg (12.3 oz) |
| Length | 161 mm |
| Width | 65 mm |
| Height | 28 mm |

Environmental Specifications

| | |
|------------------------------|-------------------------------------|
| Operating temperature | +5 °C to +40 °C (41 °F to 104 °F) |
| Storage temperature | -50 °C to +70 °C (-58 °F to 158 °F) |
| Humidity | 90 % at 25 °C (77 °F) |
| Atmospheric pressure | 70.0 kPa to 106.7 kPa |

Reflection Magnitude Errors

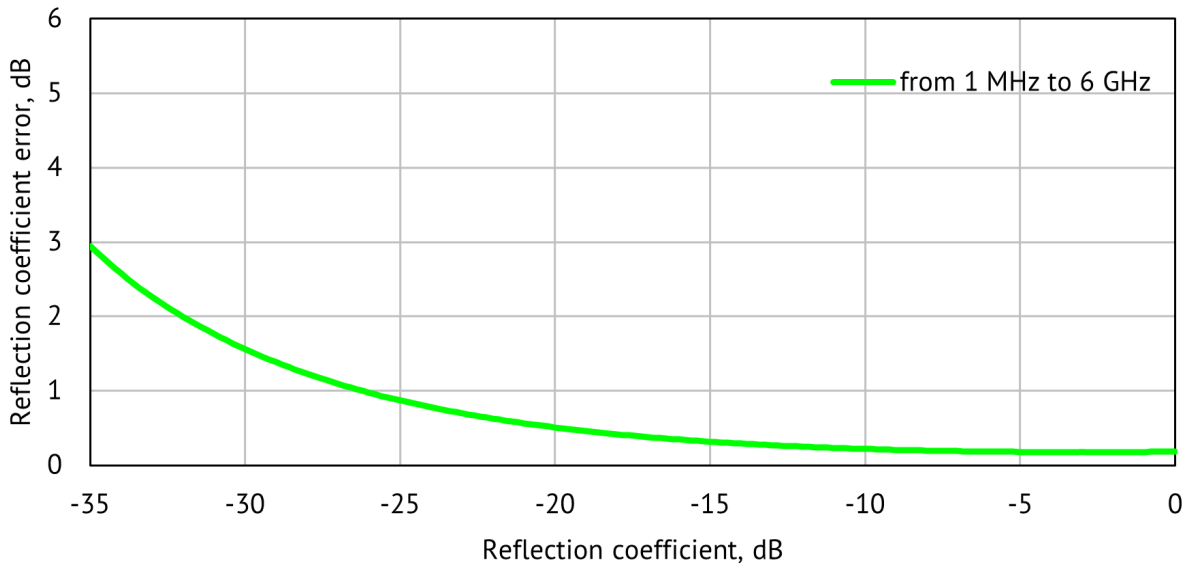
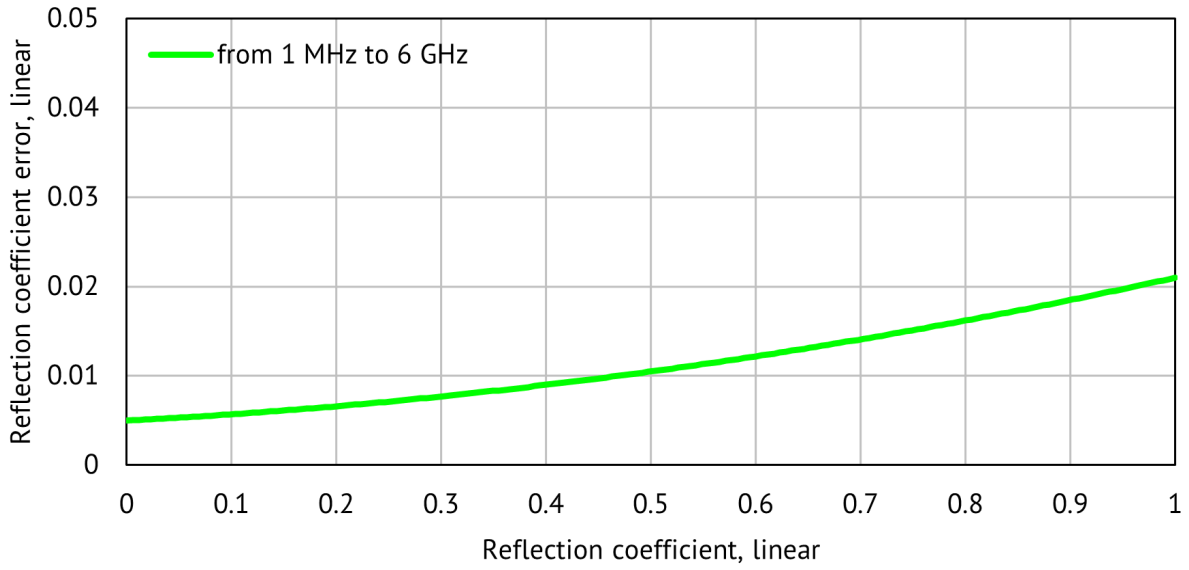

Specifications are based on an isolating DUT ($S_{21} = S_{12} = 0$)

Reflection Phase Errors

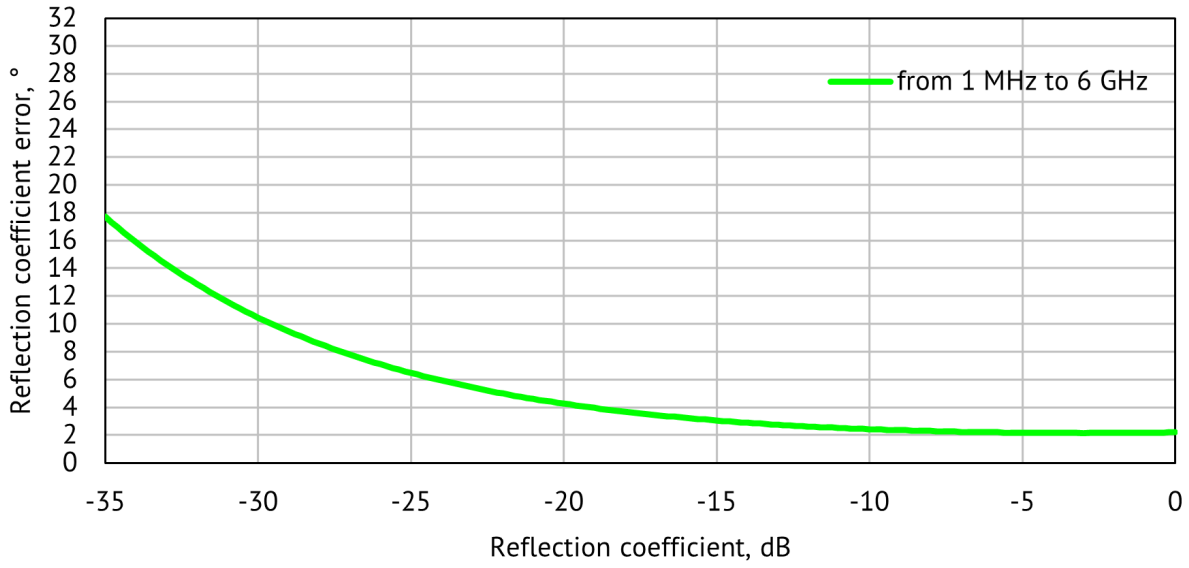

Specifications are based on isolating DUT ($S_{21} = S_{12} = 0$)

R140B

Measurement Range

| | |
|--|-------------------------|
| Impedance | 50 Ohm |
| Test port connector | |
| R140B-01 | type N, female |
| R140B-02 | type N, male |
| R140B-11 | 3.5 mm, female |
| R140B-12 | 3.5 mm, male |
| Number of test ports | 1 |
| Frequency range | 85 MHz to 14 GHz |
| Full frequency accuracy | $\pm 2.5 \cdot 10^{-6}$ |
| Frequency resolution | 25 Hz |
| Number of measurement points | 2 to 100,001 |
| Measurement bandwidths (with 1/3 steps) | 10 Hz to 300 kHz |
| Cable loss measurement range | |
| 85 MHz to 4.8 GHz | 35 dB |
| 4.8 GHz to 14 GHz | 30 dB |
| Dynamic range² | |
| 85 MHz to 4.8 GHz | 115 dB typ. |
| 4.8 GHz to 14 GHz | 100 dB typ. |

[2] Measurement of |S21| and |S12| using two reflectometers, both being connected to the same USB hub, applies over the temperature range of $(23 \pm 5)^\circ\text{C}$ after 30 minutes of warming-up, with less than 1°C deviation from the calibration temperature at high output power and IF bandwidth 100 Hz.

Measurement Accuracy^[3]

| Accuracy of reflection measurements ⁴ | Magnitude/Phase |
|--|-----------------|
| 85 MHz to 4.8 GHz | |
| -15 dB to 0 dB | ±0.4 dB / ±4° |
| -25 dB to -15 dB | ±1.2 dB / ±8° |
| -35 dB to -25 dB | ±4.0 dB / ±22° |
| 4.8 GHz to 15 GHz | |
| -15 dB to 0 dB | ±0.5 dB / ±5° |
| -25 dB to -15 dB | ±1.5 dB / ±10° |
| -35 dB to -25 dB | ±5.5 dB / ±30° |
| Accuracy of transmission magnitude measurements ⁵ | |
| 85 MHz to 4.8 GHz | |
| -50 dB to 0 dB | ±1 dB |
| 4.8 GHz to 15 GHz | |
| -40 dB to 0 dB | ±1 dB |
| Trace noise magnitude ⁶ | |
| 85 MHz to 4.8 GHz | 0.002 dB rms |
| 4.8 GHz to 14 GHz | 0.006 dB rms |
| Temperature dependence | |
| 85 MHz to 4.8 GHz | 0.008 dB/°C |
| 4.8 GHz to 14 GHz | 0.025 dB/°C |

[3] Reflection and transmission measurement accuracy applies over the temperature range of (73 ± 9) °F or (23 ± 5) °C after 30 minutes of warming up, with less than 1°C deviation from calibration temperature, at 0 dBm output power and IF BW 100 Hz. Frequency points have to be identical for measurement and calibration (no interpolation allowed).

[4] Reflection specifications are based on an isolating DUT.

[5] Transmission specifications are based on a matched DUT. Measurement of |S21| and |S12| using two devices, both being connected to the same USB hub.

[6] IF bandwidth 1 kHz.

Effective System Data

| | |
|--------------------------|----------|
| 85 MHz to 4.8 GHz | |
| Directivity | 45 dB |
| Source match | 37 dB |
| Reflection tracking | ±0.10 dB |
| 4.8 GHz to 14 GHz | |
| Directivity | 42 dB |
| Source match | 35 dB |
| Reflection tracking | ±0.20 dB |

Uncorrected System Performance

| | |
|-------------------------|--------------------|
| 85 MHz to 14 GHz | |
| Directivity | 10 dB (15 dB typ.) |
| Source match | 10 dB (15 dB typ.) |

Test Port

| | |
|------------------------------|---------|
| Output power | |
| High level | 3 dBm |
| Low level | -20 dBm |
| Interference immunity | +17 dBm |
| Damage level | +23 dBm |
| Damage DC voltage | 50 V |

Measurement Speed

| | |
|-----------------------|-------------|
| Time per point | 170 μs typ. |
|-----------------------|-------------|

Frequency Reference Input

| | |
|------------------------------|----------------|
| Port | Ref 10 MHz |
| External reference frequency | 10 MHz |
| Input level | 0 dBm to 4 dBm |
| Input impedance | 50 Ohm |
| Connector type | SMA, female |

Frequency Reference Output

| | |
|---|-----------------|
| Port | Ref 10 MHz |
| Internal reference frequency | 10 MHz |
| Output reference signal level at 50 Ohm impedance | -1 dBm to 5 dBm |
| Connector type | SMA, female |

Trigger Input

| | |
|-------------------------|----------------------------|
| Port | Ext Trig |
| External trigger source | 3.3 V CMOS, TTL compatible |
| Pulse width | $\geq 1 \mu\text{s}$ |
| Polarity | positive or negative |
| Input impedance | $\geq 10 \text{ kOhm}$ |
| Connector type | SMA, female |

1-Port Series Vector Network Analyzer Specifications

System & Power

| | |
|-------------------------------------|-------------------------------|
| CMT VNA software: | |
| Operating system (min requirements) | Windows 10, Ubuntu 24.04 |
| CPU | 4 core 2.0 GHz (x64 or arm64) |
| RAM | 8 GB |
| Interface | USB 2.0 |
| Connector type | Mini USB B |
| Power consumption | 3.5 W |

Calibration

| | |
|--|---------|
| Recommended factory adjustment interval | 3 Years |
|--|---------|

Dimensions

| | |
|---------------|------------------|
| Weight | 0.3 kg (10.6 oz) |
| Length | 127 mm |
| Width | 62 mm |
| Height | 30 mm |

Environmental Specifications

| | |
|------------------------------|-------------------------------------|
| Operating temperature | +5 °C to +40 °C (41 °F to 104 °F) |
| Storage temperature | -50 °C to +70 °C (-58 °F to 158 °F) |
| Humidity | 90 % at 25 °C (77 °F) |
| Atmospheric pressure | 70.0 kPa to 106.7 kPa |

Reflection Magnitude Errors

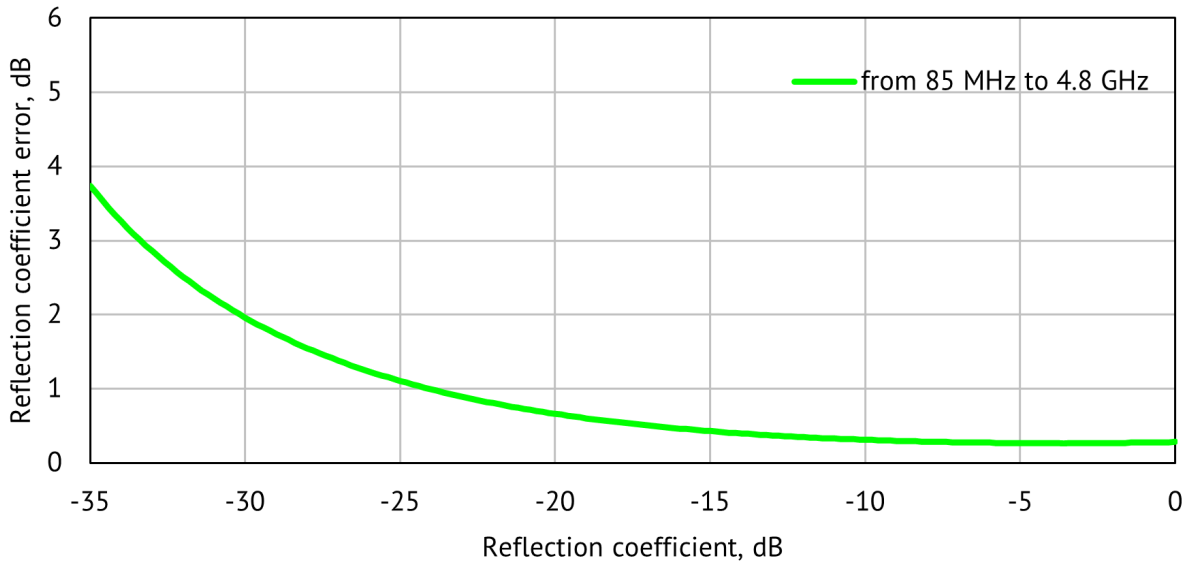
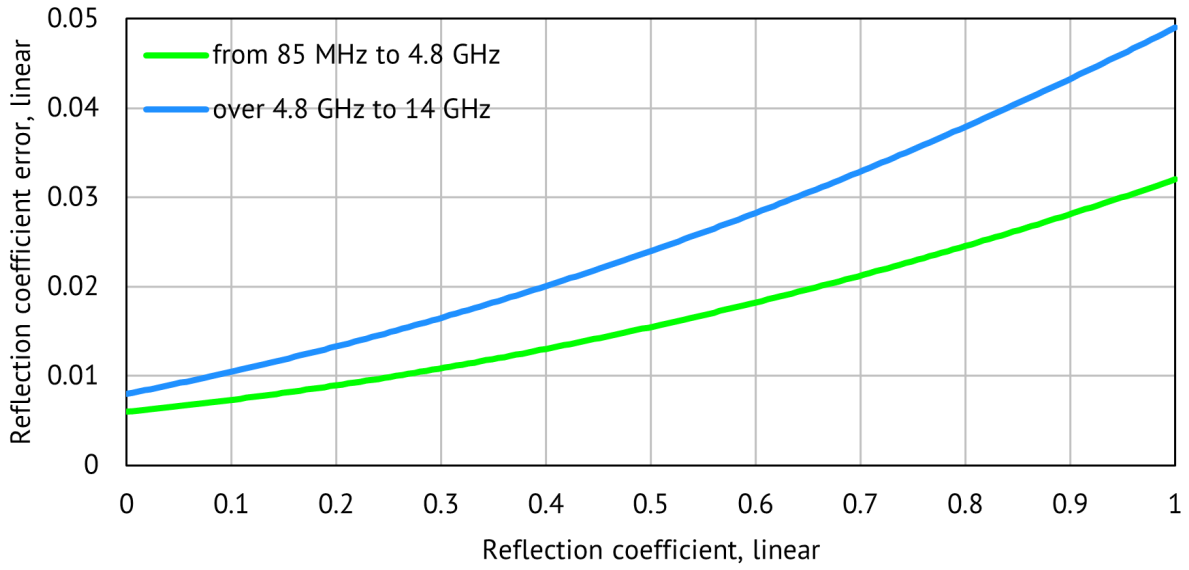

1-Port Series Vector Network Analyzer Specifications

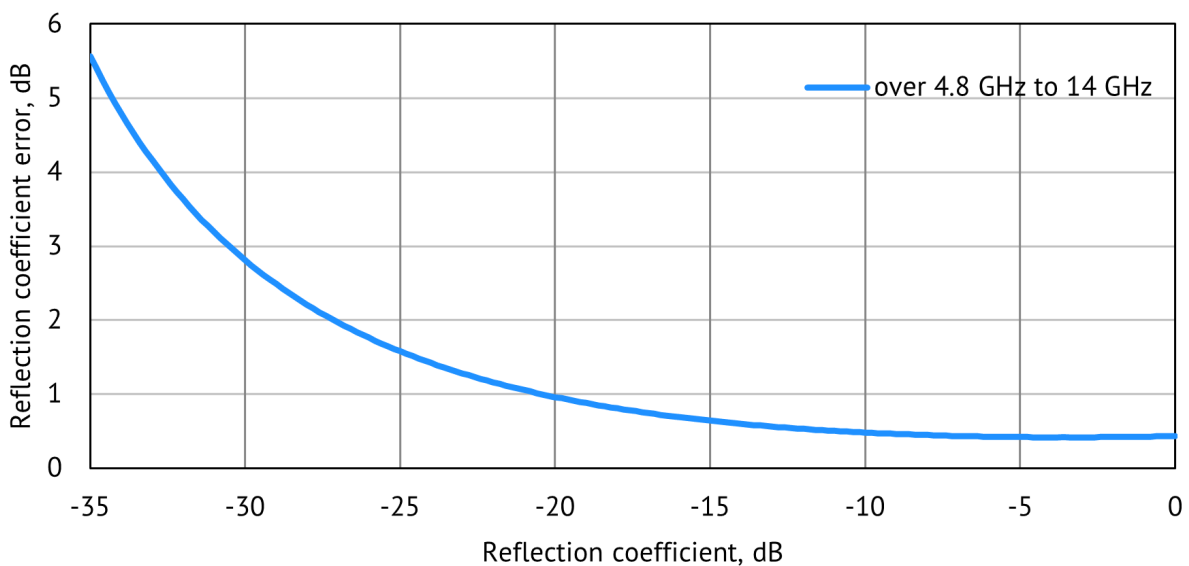

Specifications are based on an isolating DUT ($S_{21} = S_{12} = 0$)

Reflection Phase Errors

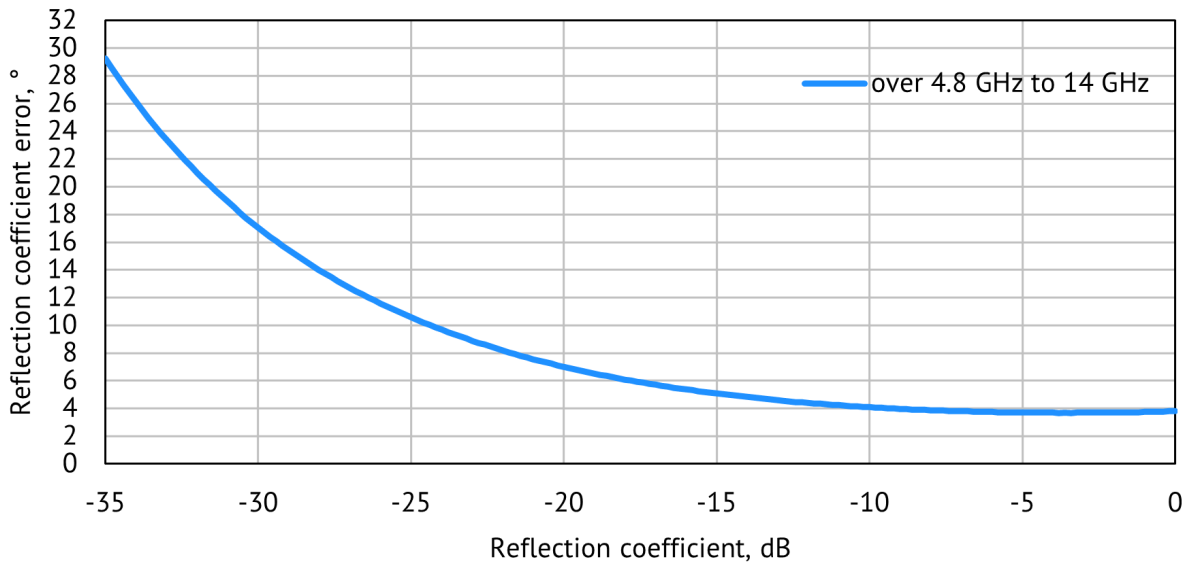
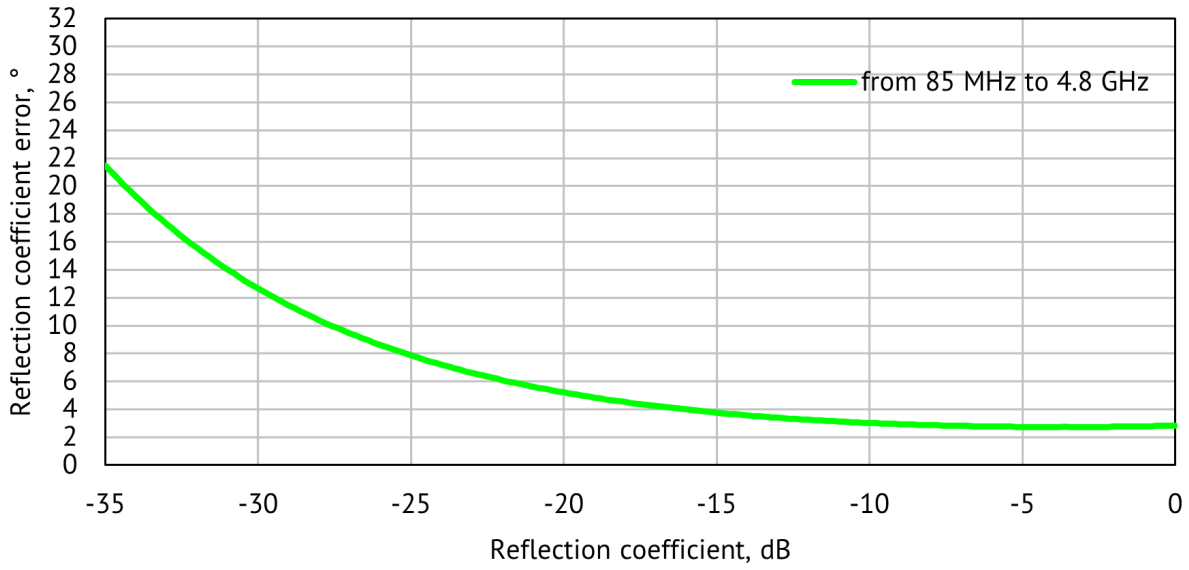

Specifications are based on isolating DUT ($S_{21} = S_{12} = 0$)