

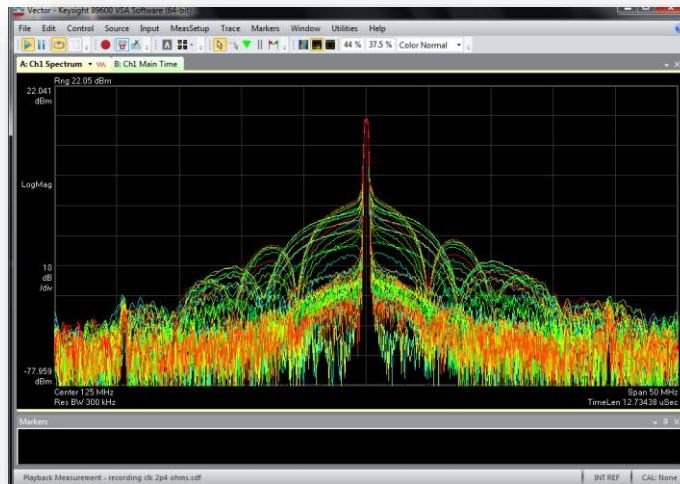

PICOTEST

USB Harmonic Comb Injector



Documentation

Version 1.3, March 2025

Copyright © 2016 Picotest

All Rights Reserved

Trademarks

The Picotest logo and “Picotest PDN Probes” are trademarks of Picotest Corp. PDN Cable® Port Saver® are registered trademarks of Picotest Corp. All other brand and product names mentioned herein are used for identification purposes only and are registered trademarks, trademarks, or service marks of their respective holders.

Copyright notice

Except as permitted under the United States Copyright Act of 1976, no part of this publication may be reproduced or distributed in any form or by any means, or stored in a data base or retrieval system, without the prior written permission of Picotest Corp. Information in this publication supersedes that in all previously published material. Specifications are subject to change without notice.

Contact information

Corporate offices 1-877 914-PICO Technical support e-mail info@picotest.com
World Wide Web <https://www.picotest.com>

Declaration of Conformity (EU)



The equipment adheres to the guidelines of the council of the European Community for meeting the requirements of the member states regarding the electromagnetic compatibility (EMC) directive and the RoHS directive.

Declaration of Conformity (UK)



The equipment adheres to the regulations of the UK government for meeting the requirements regarding the Electromagnetic Compatibility (EMC) Regulation and the Regulation for Restriction of the Use of Certain Hazardous Substances in Electrical and Electronic Equipment.

Information for disposal and recycling

The Picotest Probes and Cables and all its accessories are not intended for household use. At the end of its service life, do not dispose of the test set with household waste!



For customers in EU countries (incl. European Economic Area) Picotest test sets are subject to the EU Waste Electrical and Electronic Equipment Directive (WEEE directive). As part of our legal obligations under this legislation, Picotest offers to take back the test set and to ensure that it is disposed of by an authorized recycling facility.



For customers outside the European Economic Area
Please contact the authorities in charge of the relevant environmental regulations in your country and dispose of Picotest products and all its accessories only in accordance with your local legal requirements.

Table of Contents

| | |
|--|-----------|
| Chapter 1 - Overview | 4 |
| Welcome | 4 |
| What's Included | 5 |
| Documentation and Support | 5 |
| Warranty..... | 5 |
| Calibration..... | 5 |
| Chapter 2 – Introduction to the Harmonic Comb | 6 |
| Introduction and Usage | 6 |
| Connecting the Comb..... | 7 |
| Changing the Comb Mode | 9 |
| Sample Harmonic Comb Applications..... | 13 |
| Troubleshooting Clock Jitter | 13 |
| Chapter 3 - Specification | 17 |
| Harmonic Comb Specifications..... | 17 |
| Safety Information..... | 17 |
| Handling Information | 18 |
| Cleaning..... | 18 |

Chapter 1 - Overview

Welcome

Thank you for purchasing Picotest's J2150B USB Harmonic Comb Injector. The Harmonic Comb Injector is an ultra-portable multifunction signal generator. A comb signal generator is simply a device that produces a set of harmonically related CW signals whose spacing is based on a fundamental oscillator frequency. It has many uses including EMI, power supply and clock jitter testing, cable testing, EMC chamber testing (for measurement consistency day-to-day, and comparing one chamber to another), a general purpose source for characterizing semi-anechoic chambers and step load testing.

Comb Features and Benefits

- Wideband harmonic comb generator spans 1kHz-1GHz+
- Multiple modes include time and frequency jitter
- Easily change modes via pushbutton
- Quickly identify power supply related issues
- USB powered; replaces bulky AWGs
- Impulse and Square Wave Outputs
- Ultraportable USB stick design, Powers from any USB port

The stepped and manually-controllable frequencies of 1 kHz, 100 kHz, and 10 MHz help separate this comb generator from other generators. It is the perfect troubleshooting tool to help reveal resonances in power bus and power supply circuitry, thus maximizing stability and minimizing EMI from these sources. It's also very useful as an EMC/EMI troubleshooting tool.

What's Included

Your Picotest Harmonic Comb includes the following:

- J2150B Harmonic Comb

Documentation and Support

This documentation details the use the Comb for various types of measurements. Specifications are also included.

The support section of Picotest's web site, <https://www.picotest.com/support.html>, contains additional documentation and various publications on testing power supplies, PDN, and other circuitry using the Picotest Harmonic Comb.

Warranty

Every Picotest product you buy from Picotest.com is backed by a 1-year manufacturer's warranty. For warranty service or repair this product must be returned to a service facility designated by PICOTEST. Please contact your local service representative for further assistance.

Calibration

The Comb does not require calibration.

Chapter 2 – Introduction to the Harmonic Comb

Introduction and Usage

The Harmonic Comb Injector is a simple to use signal generator designed to support Power Integrity and EMC/EMI testing applications.

You can use the Comb to reveal resonances in power supply and voltage bus designs, as well as to support EMC/EMI measurement and troubleshooting. The generator has five different frequency modes, from 1 kHz to 10 MHz. Several of the modes are “dithered”, so as to help fill in the gaps between harmonic combs.

There are five (5) modes of operation. Mode 1 steps through three different frequency steps (1 kHz, 100 kHz and 10 MHz) in order to better reveal circuit resonances. It covers the entire frequency band up to approximately 1.5GHz.

Plugging the injector into a USB slot initially puts it into Mode 1. The mode can be selected by pressing the tactile push button. The pushbutton is sampled approximately once per second, so the button must be held for approximately 1 second for each mode increment/transition.

The injector supports 1kHz Impulse, 100kHz Impulse, 10MHz Impulse, and 10kHz Square wave outputs. Mode 1 repeatedly auto-cycles through the three impulse modes. Each impulse mode includes time and frequency jitter.

Three LEDs: red, yellow, and green indicate the mode the key is in.



Mode 1 is the default mode at power-up, and steps through modes 2 through 4 in order to excite all harmonic frequencies - thus quickly revealing problem resonances. Modes 1 through 4 include pulse width dithering to help fill in gaps between combs.

Once resonant frequencies are identified in Mode 1, Modes 2 through 4, with frequencies of 1 kHz, 100 kHz, and 10 MHz, respectively, may be used to zero in on specific resonances. For instance, the 1kHz impulse covers low frequencies nicely and the comb spurs are 1kHz apart. But the signal level falls inversely with the harmonic number, so by 10MHz there isn't any signal left. The 100kHz picks up here and at 10MHz still has decent signal with the spurs 100kHz apart. At 100kHz we have lost about 40dB, but the signal is still quite usable. Modes 2 and 3 are high enough resolution to accurately identify circuit resonances. However, the 10 MHz mode is useful in determining higher-frequency resonances for EMI troubleshooting.

Mode 5 is the exception and is a simple 50% duty cycle square wave running at 10 kHz. This is often handy for probe calibration and for simple load step testing.

The device is completely self-contained, requiring only a 5V supply from any USB port, including USB battery packs. This allows portable operation.

Useful harmonic content can easily cover up to 1.5 GHz. No external software is required for operation.

Connecting the Comb

- The Comb is powered by plugging it into any USB receptacle.



- This puts the Comb into Mode 1, which is the mode usually used for troubleshooting since it automatically cycles between modes 2-4.
- The switch is a modulo based switch, so it will roll to the beginning after mode 5.
- The output of the Comb can be connected to a probe or other cable connection via the SMA output connector.

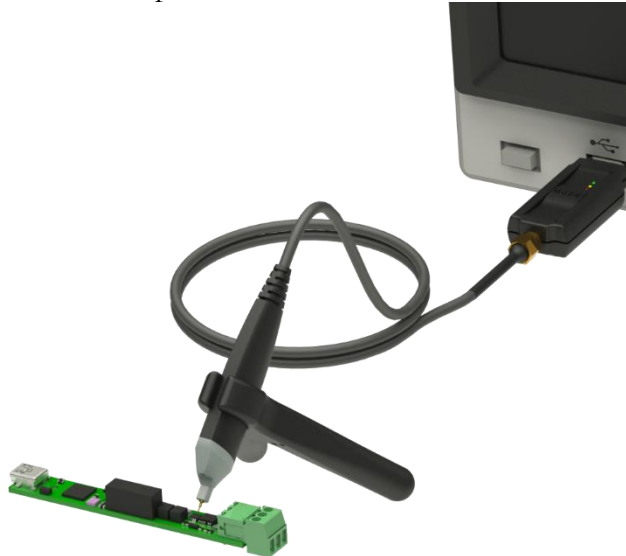

The output is DC-coupled, so the signal may be used to modulate other Picotest voltage and current injectors. The output voltage is 5V into a high impedance termination, 2.5V into 50 ohms. In order to AC-couple the output, a Picotest P2131A DC Blocker (shown below) may be used.



Usage Tip: Set your analyzer to use persistence mode. When used with Mode 1 of the Comb persistence will allow you to see more details as the Comb switches between modes.

Changing the Comb Mode

To change the Harmonic Comb mode:

- Press the large 'Mode' button on the top of the Comb for at least 1 second.



- The current mode is indicated by three LEDs as shown in the table below.

| Mode | Description | Red | Yellow | Green | Notes |
|------|---------------------------|-----|--------|-------|----------------------------|
| 1* | Steps (through modes 2-4) | x | x | x | 300ms per mode |
| 2 | 1kHz Impulse | x | | | Frequency and Width Dither |
| 3 | 100kHz Impulse | | x | | Frequency and Width Dither |
| 4 | 10MHz Impulse | | | x | Frequency and Width Dither |
| 5 | 10kHz Square Wave | x | x | | |

* DEFAULT – Selected at power on

Mode 1 steps through Modes 2, 3 and 4, in rotation, automatically changing modes every 300ms.

Modes 2, 3, and 4 outputs a series of short impulses at a steady frequency, with time and frequency jitter, each with a different resulting spectrum. Mode 2 produces noise over the frequency range of 1kHz to more than 1MHz. Mode 3 produces noise over the frequency range of 100kHz to more than 10MHz. Mode 4 produces noise over the frequency range of 10MHz to more than 1GHz.

Mode 5 outputs a simple 10kHz square wave. It can be used to drive an electronic load, such as the J2111B, J2112A, or S10 Current Injectors, as a transient step load source.

The output of the Harmonic Comb output is shown below.



Figure 1: Pulses from the Comb are shaped and run into a driver circuit that creates a 470 ps rise and 270 ps fall time (typical).

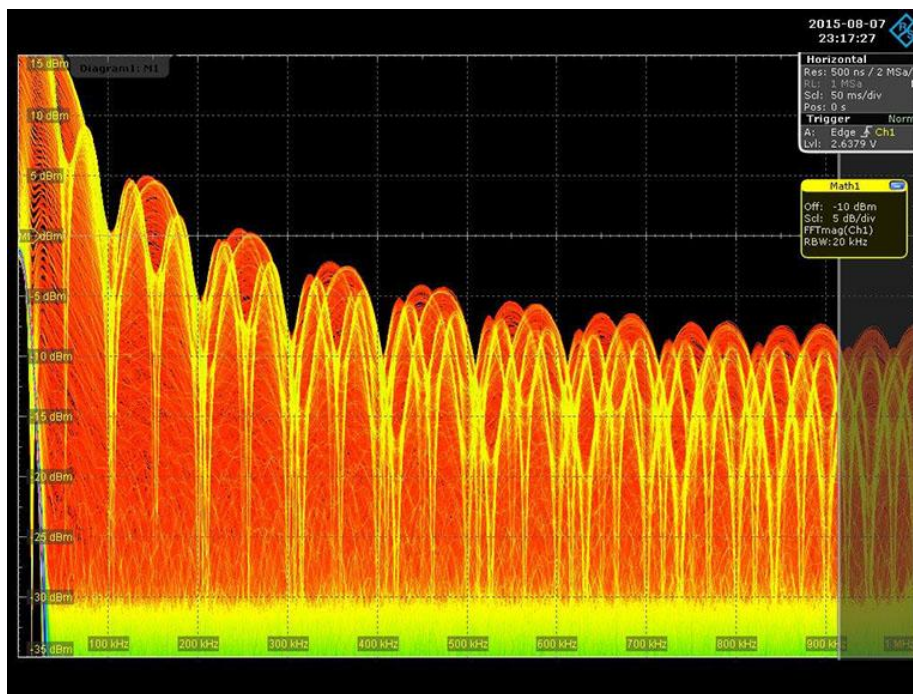

Figures 2: The spectrum when using Mode 2 (1 kHz dithered fundamental).

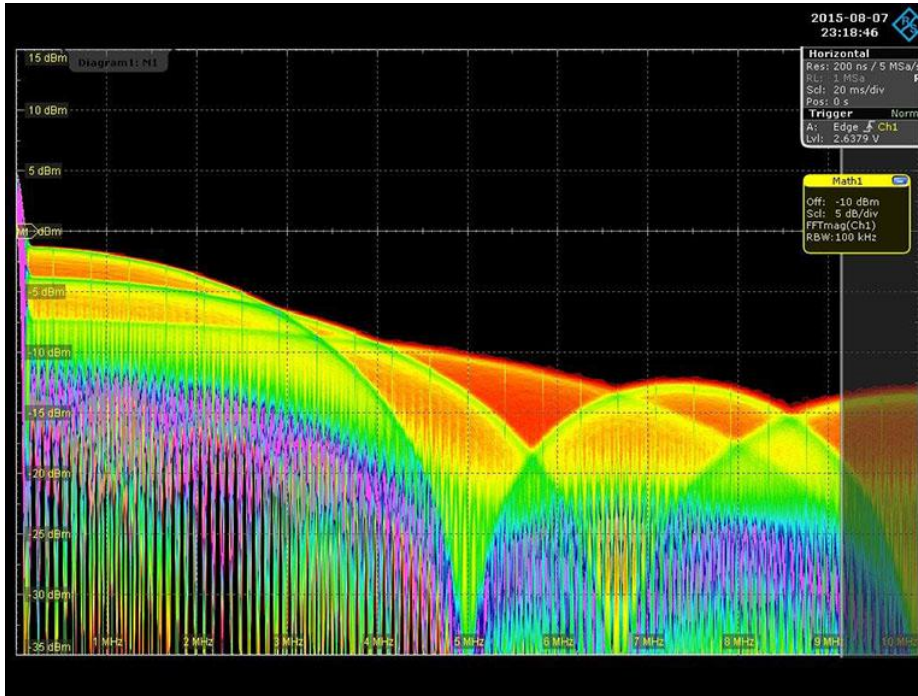

Figures 3: The spectrum when using Mode 3 (100 kHz dithered fundamental).

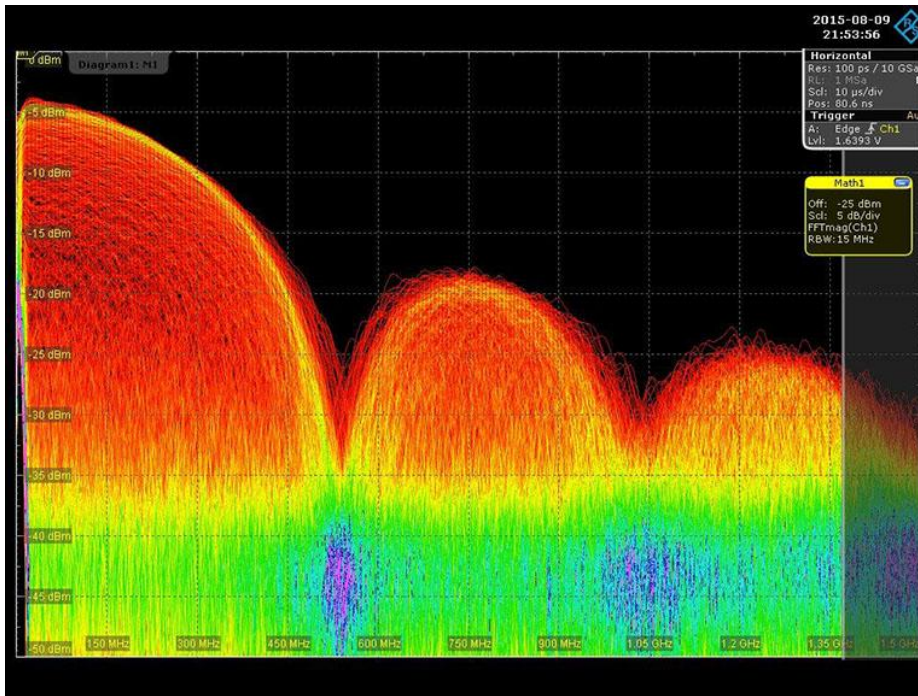

Figure 4: This figure shows a typical harmonic output up to 1 GHz when using Mode 4 (10 MHz dithered fundamental). This mode would be useful for verification of EMI test chambers.

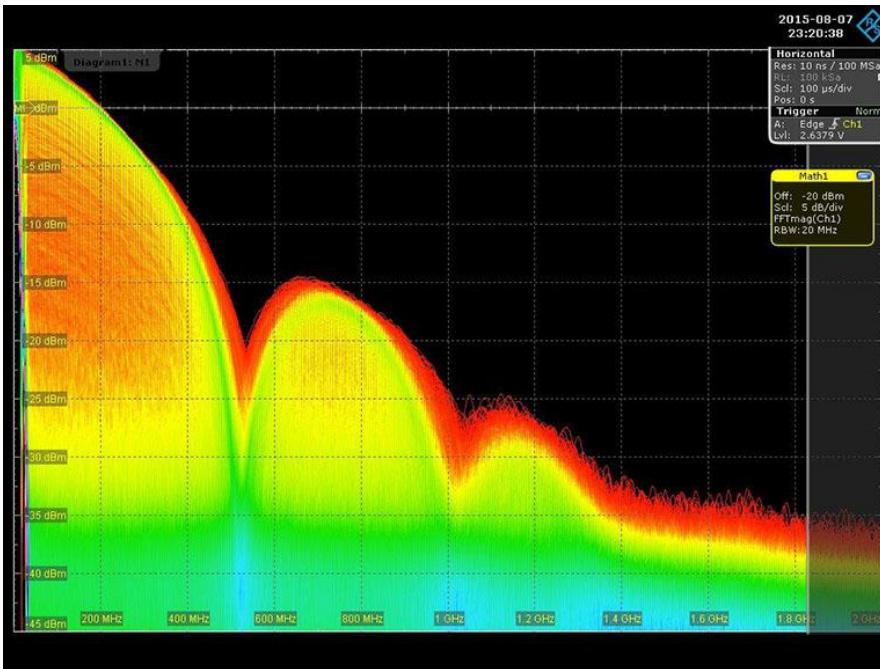

Figure 5: Mode 1 (default sweep mode) includes stepped impulse responses with frequency and width dithering.

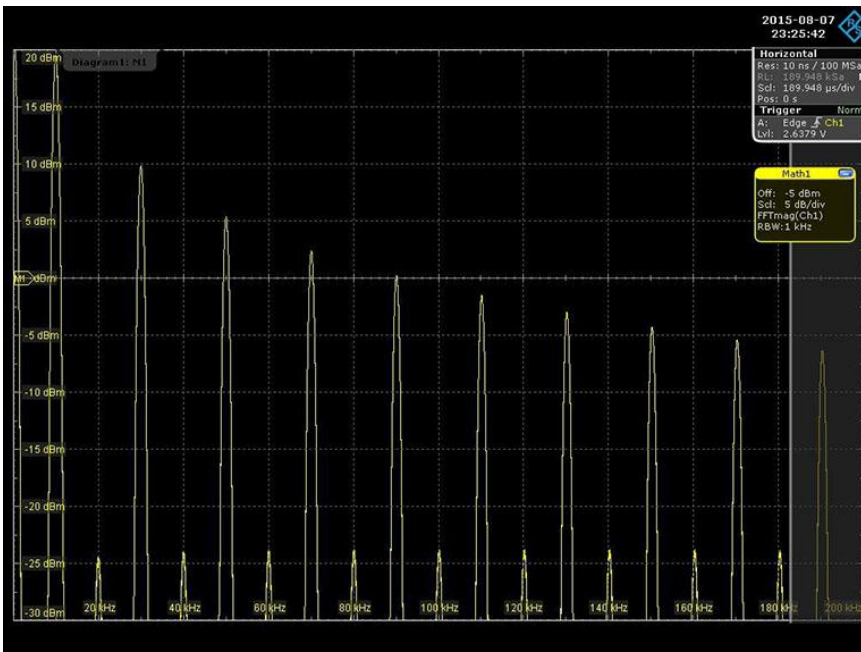

Figure 6: 10kHz square wave (~50% duty). Mode 5 produces a 10kHz pulse with a duty cycle of approximately 50% as noted by the low level of even harmonics. This pulse can be used to modulate a current injector or as a calibration edge.

Sample Harmonic Comb Applications

Power integrity testing and troubleshooting is really where the Harmonic Comb Injector shines. By injecting closely-spaced harmonic combs into the power bus or control loop of a linear or switching power supply, it's possible to reveal troublesome resonances that could potentially cause instability or EMI due to ringing on switched waveforms.

Picotest has one- and two-port probes that may be used, along with the Harmonic Comb Injector, to hunt for problem resonances within your power bus circuitry. Shown below are several such examples.

Troubleshooting Clock Jitter

In the figures below, we are injecting 100 kHz square wave (Mode 5) into the 3.3V power bus from a linear regulator supplying a 125 MHz crystal oscillator.

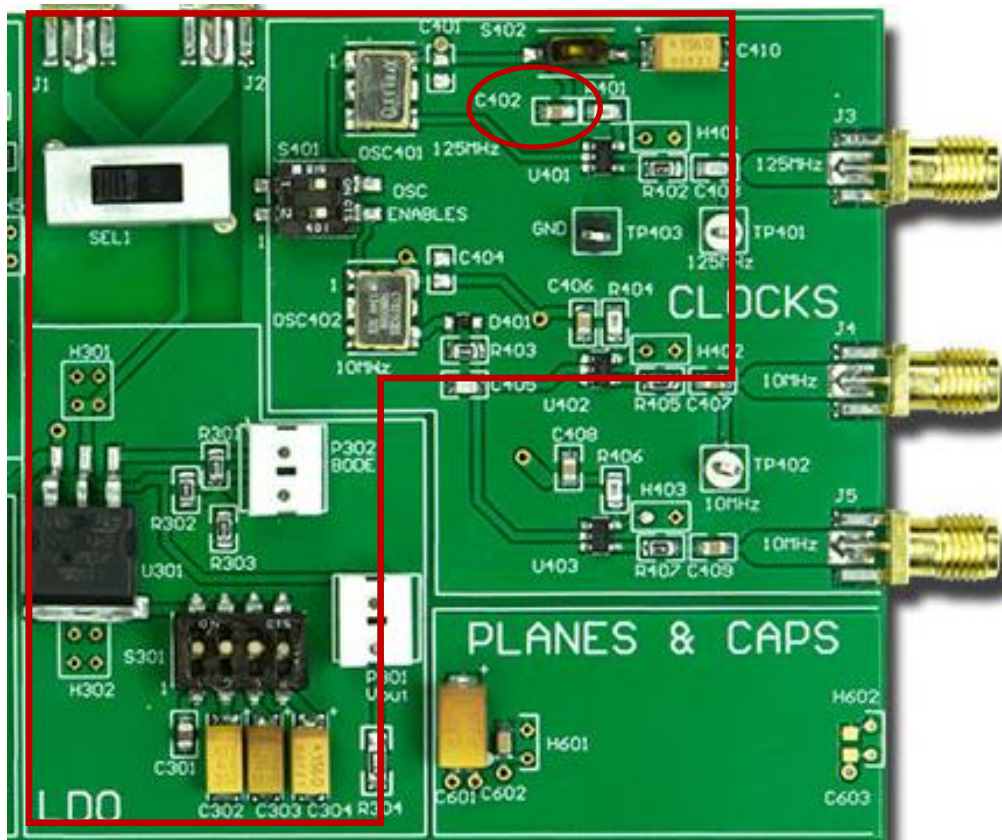

Figure 7: VRTS3 Training board showing the LDO and clock. The Comb signal is injected into capacitor C402, the power rail for the clock oscillator.

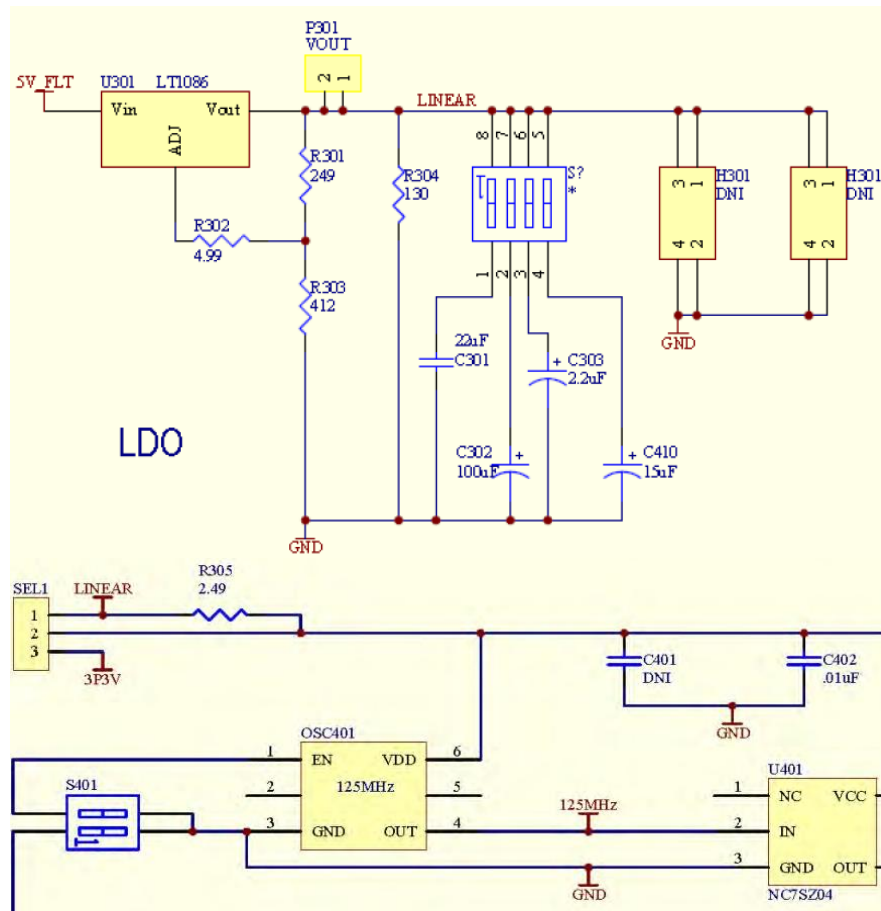

Figure 8: The LDO and Clock circuitry.

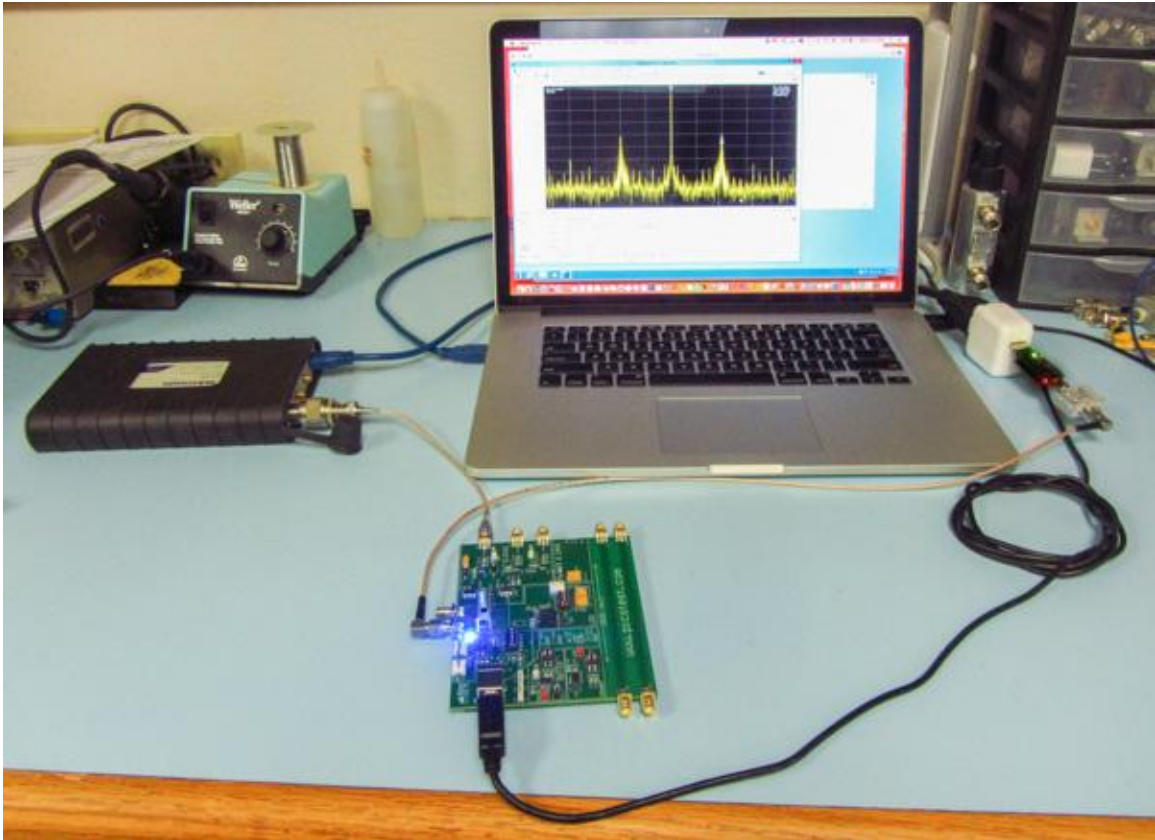

Figure 9: Test setup for measuring resonances within the power bus structure.

With the spectrum analyzer centered on 125 MHz, you can readily observe a 7 MHz resonance as sidebands of the clock.

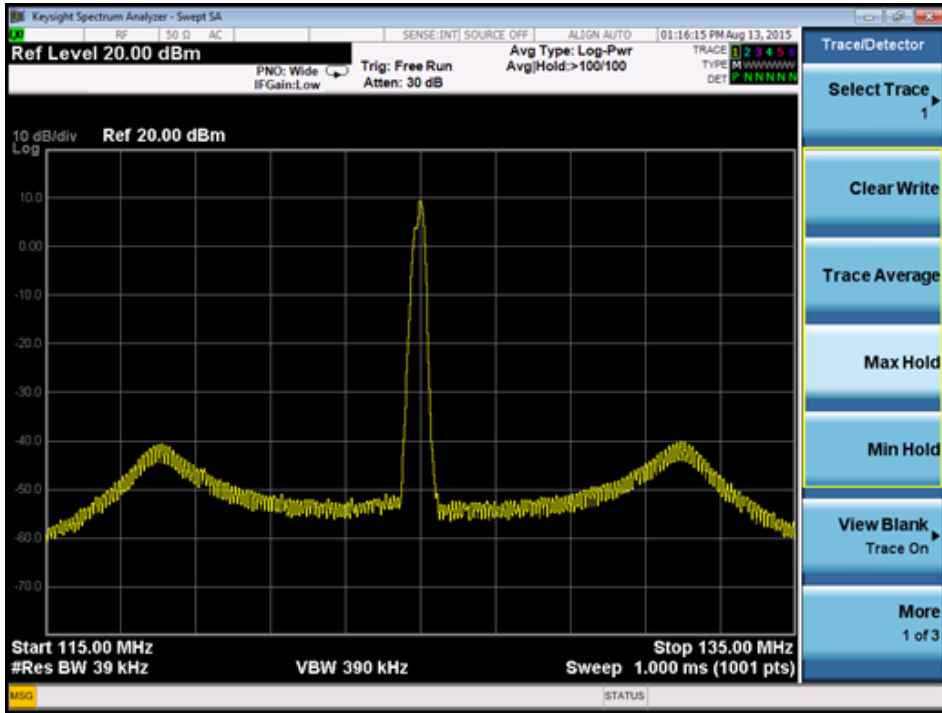

Figure 10: Power bus resonances at 7 MHz are shown as sidebands to the 125 MHz clock.

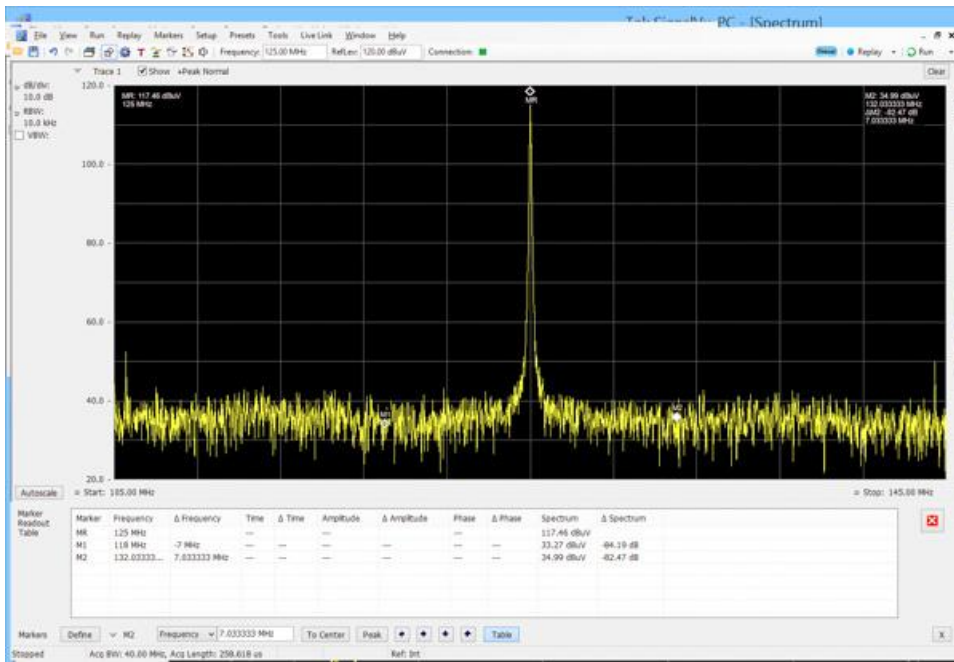

Figure 11: By adding an additional 15 uF capacitor to the 3.3V bus, the resonance is eliminated.

Chapter 3 - Specification

Specifications that are not defined to be guaranteed are typical and are published as general information to the user. The instrument should have warmed-up for at least 20 minutes and the environmental conditions do not exceed the Comb's specified limits.

Harmonic Comb Specifications

| J2150B | |
|--------------------------|--|
| Characteristic | Rating |
| Output | -13dBm typical 1kHz and 100kHz -17dBm typical 10MHz 10kHz square wave 13dBm, typical Duty cycle 50% DC coupled 0 to +2.5V pulse into 50Ohms |
| Rise/Fall Time | Typical rise/fall time 470ps/270ps |
| Comb connections | SMA |
| Output Impedance | 50 Ohm |
| Operating Temperature | 0 to 45° C (32° F to 104° F) at 80% relative humidity |
| Absolute Maximum Voltage | < 50VAC and 75VDC |



Safety Information

To avoid personal injury and to prevent fire or damage to this product or products connected to it, review and comply with the following safety precautions. Be aware that if you use this Comb assembly in a manner not specified, the protection this product provides may be impaired. Only qualified personnel should use this Comb assembly. Do not connect the Comb to any voltage that exceeds the maximum permissible input voltage specified in the data sheet. Non-compliance with this instruction carries the risk of an electric shock. Make sure not to cause any short circuits when performing measurements on sources with high output currents. Short circuits may cause injuries or burns.

Use only grounded instruments.

Do not connect the Comb ground (USB connector) to a potential other than ground or earth ground or to any power source that isn't grounded. Always make sure the Comb and the measurement instrument/power source are grounded properly.

Observe Comb ratings.

Do not apply any electrical potential to the Comb input which exceeds the maximum ratings of the Comb.

Do not operate with suspected failures.

Refer to qualified service personnel.

Indoor use only.

Do not operate in wet/damp environment. Keep product surfaces dry and clean. Do not operate the product in an explosive atmosphere.

Handling Information



Handle with care to avoid any injury. Note that the Comb cable is a sensitive part of the Comb and connector. Do not damage through excessive bending or pulling. Avoid mechanical shock to this product in general to guarantee accurate performance and protection.



Caution: To avoid equipment damage and/or severe injuries or death ensure that the absolute maximum ratings defined in this manual are observed at all times and never exceeded.

Cleaning

To clean the exterior of the Comb, use a soft cloth moistened with either distilled water or isopropyl alcohol. Before use allow the Comb to dry completely.